

FlowDrain - FG200 channel system with galvanized steel frame

Nine foot channel

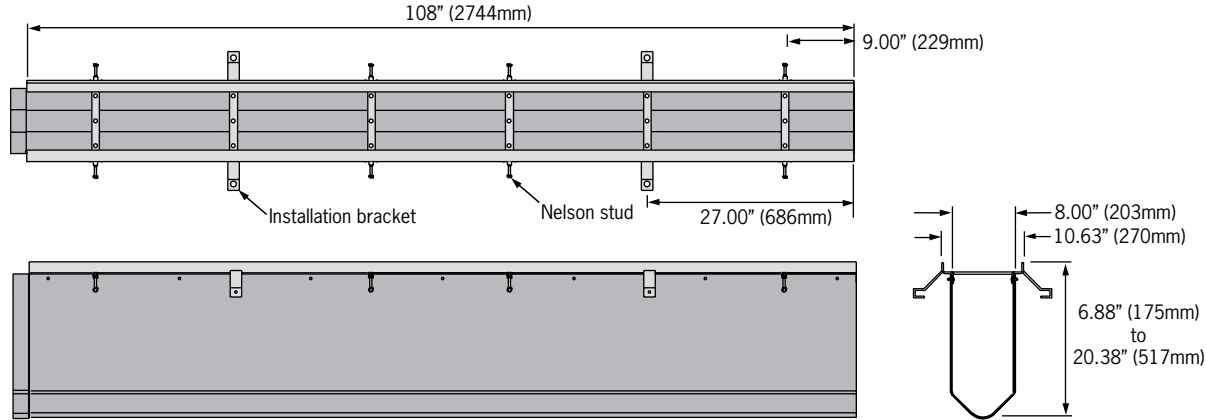

Three foot channel

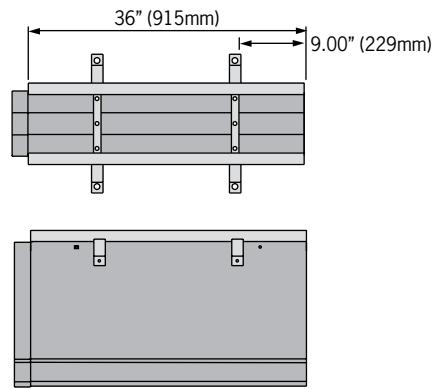

Vertical outlet adapter

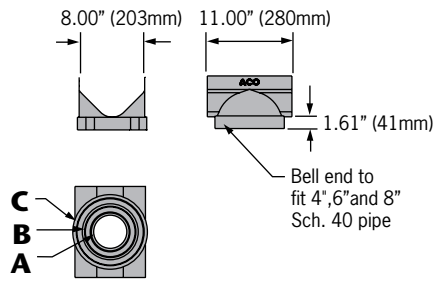

Channel Collar

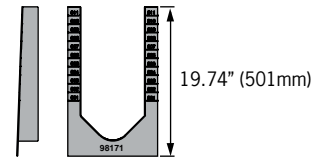

Closing cap - Female

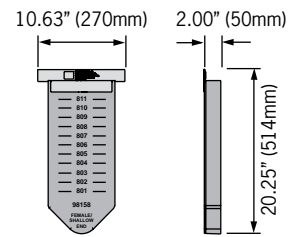

Closing cap - Male

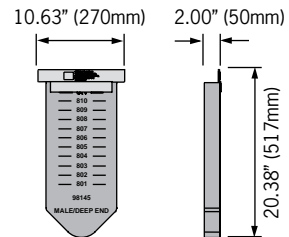

Outlet end cap

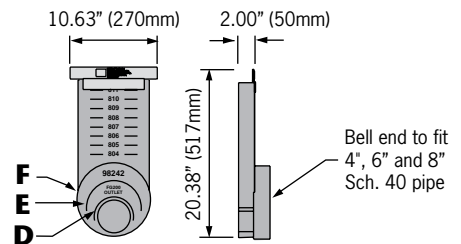

Outlet flow rates

Outlet	Product	Outlet size (Sch. 40)	Invert Depth	GPM	CFS
A	Vertical outlet - F801	4" round	7.88	154	0.34
A	Vertical outlet - F812	4" round	20.25	246	0.54
B	Vertical outlet - F801	6" round	7.88	346	0.77
B	Vertical outlet - F812	6" round	20.25	553	1.23
C	Vertical outlet - F801	8" round	7.88	616	1.37
C	Vertical outlet - F812	8" round	20.25	982	2.18
D	Outlet cap - F802	4" round	9.00	145	0.33
D	Outlet cap - F812	4" round	20.25	233	0.54
E	Outlet cap - F803	6" round	10.13	330	0.76
E	Outlet cap - F812	6" round	20.25	510	1.17
F	Outlet cap - F805	8" round	12.38	635	1.46
F	Outlet cap - F812	8" round	20.25	880	2.03

Note: These are the pipe flow rates at the specified outlet, NOT channel flow rates.

ACO Specification Information

ACO DRAIN

FlowDrain - FG200 channel system with galvanized steel frame



ACO Specification Information

Description	Part No.	Invert Depth		Weight lbs.
		inches	mm	
F801 Sloped channel - 108" (2.75m)	99006	6.75 - 7.88	172 - 200	11.0
F802 Sloped channel - 108" (2.75m)	99013	7.88 - 9.00	200 - 229	12.0
F803 Sloped channel - 108" (2.75m)	99021	9.00 - 10.13	229 - 257	13.0
F803N Neutral channel - 108" (2.75m)	99048	10.13	257	15.5
F803N3 Neutral channel - 36" (0.915m)	99034	10.13	257	5.2
F804 Sloped channel - 108" (2.75m)	99055	10.13 - 11.25	257 - 286	14.1
F805 Sloped channel - 108" (2.75m)	99062	11.25 - 12.38	286 - 314	15.2
F806 Sloped channel - 108" (2.75m)	99071	12.38 - 13.50	314 - 343	16.3
F806N Neutral channel - 108" (2.75m)	99095	13.50	343	16.3
F806N3 Neutral channel - 36" (0.915m)	99084	13.50	343	5.5
F807 Sloped channel - 108" (2.75m)	99109	13.50 - 14.63	343 - 371	17.4
F808 Sloped channel - 108" (2.75m)	99116	14.63 - 15.75	371 - 400	18.5
F809 Sloped channel - 108" (2.75m)	99123	15.75 - 16.87	400 - 429	19.6
F809N Neutral channel - 108" (2.75m)	99145	16.87	429	19.6
F809N3 Neutral channel - 36" (0.915)	99132	16.87	429	6.5
F810 Sloped channel - 108" (2.75m)	99156	16.87 - 18.00	429 - 457	20.7
F811 Sloped channel - 108" (2.75m)	99162	18.00 - 19.13	457 - 486	21.8
F812 Sloped channel - 108" (2.75m)	99175	19.13 - 20.25	486 - 514	23.0
F812N Neutral channel - 108" (2.75m)	99192	20.25	514	23.0
F812N3 Neutral channel - 36" (0.915)	99186	20.25	514	7.7
Channel Frames				
Galvanized steel frame - 108" (2.75m)	97079	-	-	57.9
Galvanized steel frame - 36" (0.915)	98538	-	-	19.3
Catch Basins				
Please refer to separate sheet for F600 and F880 catch basin information				
Accessories				
Closing cap (F) with galv steel end frame	98386	-	-	1.1
Closing/outlet cap (M) with galv steel end frame	98382	-	-	1.3
Outlet cap (M) with galv steel end frame	98381	-	-	1.8
Vertical outlet adapter - 4" or 6" Sch. 40 outlet	98103	-	-	1.6
FG200 Channel/catch basin collar	98171	19.74	501	1.1

Notes:

1. Invert depths are for the channel/catch basin body & frame assembly
2. Channel weights are for fiberglass body only
3. Closing caps can be cut down to suit all channels
4. Add 2" to length of each channel for female joining flange (only applicable at shallowest end of run)
5. Frames supplied with plastic snap-fit studs for connecting to fiberglass body
6. (F) =female
7. (M) = male

Specifications

General

The surface drainage system shall be ACO Drain FG200 complete with galvanized steel frame and bolted gratings as manufactured by ACO Polymer Products, Inc. or equal approved.

Materials

The trench system bodies shall be manufactured from fiberglass, with minimum properties as follows:

Compressive strength:	24,400 psi
Flexural strength:	9,943 psi
Water absorption	0.33%
Frost proof	
Salt proof	
Dilute acid and alkali resistant	

The nominal clear opening shall be 8.00" (203mm) with overall width of 10.63" (270mm). Pre-cast units shall be manufactured with either an invert slope of 1.0% or with neutral invert and have a wall thickness of at least 0.125" (3mm). Each unit will feature a full 'V' profile in the trench bottom and a 2" (50mm) male to female interconnecting end profile.

The fiberglass channel body shall be fixed to the frame using push fit nylon studs at 17.17" (436mm) intervals.

Frames shall be manufactured from galvanized steel and shall incorporate anchoring features to ensure maximum mechanical bond to the surrounding bedding material and pavement surface. Frames shall incorporate installation brackets to ensure correct and easy installation. Frame shall be at least 3/16" (5mm) thick.

Grates

Grates should be specified. See separate ACO Spec Info grate sheets for details.

Installation

The trench drain system shall be installed in accordance with the manufacturer's installation instructions and recommendations.

ACO, Inc.

Northeast Sales Office
9470 Pinecone Drive
Mentor, OH 44060
Tel: (440) 639-7230
Toll free: (800) 543-4764
Fax: (440) 639-7235

West Sales Office
825 W. Beechcraft St.
Casa Grande, AZ 85122
Tel: (520) 421-9988
Toll Free: (888) 490-9552
Fax: (520) 421-9899

Southeast Sales Office
4211 Pleasant Road
Fort Mill, SC 29708
Toll free: (800) 543-4764
Fax: (803) 802-1063

Follow us on



Electronic Contact:
info@ACODrain.us
www.ACODrain.us



© April 2018 ACO, Inc. This information is believed to be accurate but it is not guaranteed to be so. We cannot assume liability for results that buyer obtains with our product since conditions of use are beyond the control of the company. It is the customer's responsibility to evaluate suitability and safety of product for his own use. ACO, Inc. reserves the right to change the product and specifications without notice.